

GSTR 2006/8 - Goods and services tax: the margin scheme for supplies of real property acquired on or after 1 July 2000

! This cover sheet is provided for information only. It does not form part of *GSTR 2006/8 - Goods and services tax: the margin scheme for supplies of real property acquired on or after 1 July 2000*

! This ruling is being reviewed as a result of a recent court/tribunal decision. Refer to Decision Impact Statement: [Brady King Pty Ltd v Commissioner of Taxation \(VID 140 of 2008\)](#).

! This document has changed over time. This is a consolidated version of the ruling which was published on *3 March 2010*



Goods and Services Tax Ruling

Goods and services tax: the margin scheme for supplies of real property acquired on or after 1 July 2000

Contents	Para
What this Ruling is about	1
Date of effect	6
Margin scheme rulings	11
Background	12
Ruling with Explanation	15
Detailed contents list	182

Preamble

*This document is a ruling for the purposes of section 105-60 of Schedule 1 to the **Taxation Administration Act 1953**. You can rely on the information presented in this document which provides advice on the operation of the GST system.*

[Note: This is a consolidated version of this document. Refer to the Tax Office Legal Database (<http://law.ato.gov.au>) to check its currency and to view the details of all changes.]

What this Ruling is about

1. This Ruling is about how the margin scheme under Division 75 of the *A New Tax System (Goods and Services Tax) Act 1999* (GST Act) applies to a supply of a freehold interest, stratum unit, or long term-lease (referred to collectively as 'real property') you acquired on or after 1 July 2000.

2. The Ruling does not apply to supplies of real property if you acquired the property on or after 1 July 2000, but the supply to you:

- (a) was GST-free under subsection 38-445(1A); and
- (b) was related to a supply before 1 July 2000, by way of lease, that would have been GST-free under section 38-450 had it been made on or after 1 July 2000 (item 2A of the table in subsection 75-10(3)).

3. Instead, the GST treatment of these supplies is addressed in Goods and Services Tax Ruling GSTR 2000/21¹ and Goods and Services Tax Ruling GSTR 2006/7.²

4. This Ruling discusses:

- (a) what is the margin scheme and when you can apply it (paragraphs 12 to 35);
- (b) when do you supply or acquire real property (paragraphs 36 to 39);

¹ Goods and services tax: the margin scheme for supplies of real property held prior to 1 July 2000.

² Goods and services tax: how the margin scheme applies to a supply of real property made on or after 1 December 2005 that was acquired or held before 1 July 2000.

- (c) whether you can use the margin scheme when you supply a tenancy in common interest in real property (paragraphs 40 to 44);
- (d) when the Commissioner will allow you to apply the margin scheme although the agreement of the supplier and recipient to apply the margin scheme is made after the supply has been made (paragraphs 18 to 19);
- (e) how the margin for the supply is worked out under subsection 75-10(2) (paragraphs 45 to 68);
- (f) the consideration for the supply and acquisition (paragraphs 47 to 57);
- (g) the application of section 75-11 for supplies of real property involving:
 - (i) GST groups (paragraphs 72 to 87);
 - (ii) GST joint ventures (paragraphs 88 to 93);
 - (iii) deceased estates (paragraphs 94 to 105); and
 - (iv) associates (paragraphs 106 to 111);
- (h) approved valuations (paragraphs 115 to 132);
- (i) increasing adjustments if part of your acquisition was ineligible for the margin scheme (paragraphs 147 to 170);
- (j) working out the margin if not all the consideration has been paid (paragraphs 171 to 174);
- (k) entitlement to input tax credits (paragraph 176);
- (l) tax invoices (paragraph 177); and
- (m) record keeping requirements (paragraphs 178 to 181).

5. Unless otherwise stated, all legislative references in this Ruling are to the GST Act.

Date of effect

6. This Ruling, except for the legislative amendments made by the *Tax Laws Amendment (2005 Measures No. 2) Act 2005* (2005 Amendment Act), the *Tax Laws Amendment (2008 Measures No. 5) Act 2008* (2008 Amendment Act), and the requirements for making valuations contained in *A New Tax System (Goods and Services Tax) Margin Scheme Valuation Requirements Determination MSV 2005/1* (MSV 2005/1), *A New Tax System (Goods and Services Tax) Margin Scheme Valuation Requirements Determination MSV 2005/3* (MSV 2005/3) and *A New Tax System (Goods and Services Tax) Margin Scheme Valuation Requirements Determination MSV 2009/1* (MSV 2009/1), explains the Commissioner's view of the law as it applies before and after the date of issue of the Ruling. The legislative amendments and the legislative instruments have different dates of effect depending on when the relevant supply is made.

7. The legislative amendments contained in the 2005 Amendment Act apply to supplies made on or after 17 March 2005, except for the amendments to section 75-5. The amendments to section 75-5 apply to supplies on or after 29 June 2005³ that are:

- (a) made under contracts entered into on or after 29 June 2005; and
- (b) are not made pursuant to rights or options granted before 29 June 2005.

7A. The legislative amendments to Division 75 contained in the 2008 Amendment Act apply to supplies of real property where the real property was acquired on or after 9 December 2008^{5A} and was not acquired:

- (a) under a written agreement entered into before 9 December 2008; or
- (b) pursuant to a right or option granted before 9 December 2008;

that specifies in writing the consideration, or a way of working out the consideration, for the supply.

8. The valuation requirements in MSV 2005/1 apply to supplies made on or after 17 March 2005 and before 1 December 2005. MSV 2005/3 applies to supplies made on or after 1 December 2005 and before 1 March 2010. The requirements in MSV 2009/1 apply to supplies made on or after 1 March 2010, except those requirements for making valuations obtained by the Commissioner which apply to supplies made before, and on or after 1 March 2010.

9. You can rely upon this Ruling on and from its date of issue for the purposes of section 105-60 of Schedule 1 to the *Taxation Administration Act 1953* (TAA). Goods and Services Tax Ruling GSTR 1999/1 explains the GST rulings system and the Commissioner's view of when you can rely on this interpretation of the law in GST public and private rulings.

10. [Omitted]

Margin scheme rulings

11. There are three main public rulings dealing with the margin scheme. The following table summarises the major differences between the three rulings and may assist the reader in ascertaining which ruling is relevant to their circumstances.

³ The date of Royal Assent of the 2005 Amendment Act.

^{5A} The date of Royal Assent of the *Tax Laws Amendment (2008 Measures No. 5) Act 2008*.

Ruling Number	Description of the contents
GSTR 2000/21 ⁴	Applies where the real property was acquired or held before 1 July 2000 and was supplied before 1 December 2005.
GSTR 2006/7 ⁵	Applies where the real property was acquired or held before 1 July 2000 and was supplied on or after 1 December 2005.
GSTR 2006/8 ⁶	Applies where the real property that was supplied was acquired on or after 1 July 2000.

Background

12. If you make a taxable supply of real property, the GST payable under the basic rule in section 9-70 is 1/11th of the price.⁷ However, under subsection 75-5(1), if you make a taxable supply of real property by:

- (a) selling a freehold interest in land;
- (b) selling a stratum unit; or
- (c) granting or selling a long-term lease,

you may apply the margin scheme, if you and the recipient have agreed in writing that the margin scheme is to apply.⁸

13. Under the margin scheme, the GST payable on the supply of real property is 1/11th of the margin for the supply. The margin for the supply is the amount by which the consideration for the supply exceeds the consideration⁹ for the acquisition of the real property unless subsection 75-10(3)¹⁰ or section 75-11 applies. Section 75-11 applies to supplies made on or after 17 March 2005.

⁴ GSTR 2000/21 Goods and services tax: the margin scheme for supplies of real property held prior to 1 July 2000.

⁵ GSTR 2006/7 Goods and services tax: how the margin scheme applies to a supply of real property made on or after 1 December 2005 that was acquired or held before 1 July 2000.

⁶ GSTR 2006/8 Goods and services tax: the margin scheme for supplies of real property acquired on or after 1 July 2000.

⁷ Sections 9-70 and 9-75.

⁸ The requirement for the agreement to be in writing does not apply if the supply falls within the former subsection 75-5(1). The former subsection 75-5(1) is addressed at paragraphs 20 to 26 and 28.

⁹ Consideration in each case is inclusive of GST, if any.

¹⁰ Subsection 75-10(3) applies to supplies of real property acquired or held before 1 July 2000.

14. The GST payable under the margin scheme is usually lower than when the GST is worked out under the basic rule in section 9-70. Because of this, the margin scheme is used particularly if the recipient of the supply is not entitled to an input tax credit for the acquisition. The most common example is residential land or residential premises supplied to private owners for their own use or for investment purposes. However, the supplier can calculate GST under the margin scheme for supplies of all types of real property¹¹ including residential, commercial, retail and industrial property.

Ruling with Explanation

When can you apply the margin scheme?

15. Subsection 75-5(1) deals with applying the margin scheme. It was amended by the 2005 Amendment Act. At the same time, subsection 75-5(1A) was inserted into the GST Act. The 2005 Amendment Act received Royal Assent on 29 June 2005.

16. Subsection 75-5(1A) and the amendment to subsection 75-5(1) apply to supplies that are:

- (a) made under contracts entered into on or after 29 June 2005; and
- (b) are not made pursuant to rights or options granted before 29 June 2005.

17. In all other circumstances, subsection 75-5(1) prior to its amendment applies.

Amended subsection 75-5(1) and subsection 75-5(1A)

18. Subsection 75-5(1) provides that you may use the margin scheme if the supplier and the recipient have agreed in writing that the margin scheme is to apply. Subsection 75-5(1A) provides that the agreement must be made on or before making the supply, or within such further period as the Commissioner allows.¹²

19. The decision to allow or not allow a further period within which to make an agreement is a reviewable GST decision under item 51 in the table in subsection 110-50(2) of Schedule 1 to the TAA.

¹¹ Provided the supply is a sale of a freehold interest or stratum unit or a grant or sale of a long-term lease and the other requirements of section 75-5 are met.

¹² Guidelines regarding when the Commissioner may allow a further period to make an agreement are set out in Law Administration Practice Statement PS LA 2005/15 which deals with the Commissioner's discretion to extend the time in which the agreement in writing must be made to apply the margin scheme under Division 75 of the GST Act.

Subsection 75-5(1) prior to its amendment

20. Subsection 75-5(1) prior to its amendment applies to supplies where the contract for the real property was entered into before 29 June 2005¹³.

21. Similarly, if prior to 29 June 2005, the recipient of the supply had a right or option to purchase real property, then when the right or option is exercised, the supply of this property falls within subsection 75-5(1) prior to its amendment.¹⁴

22. It provides that the supplier 'may choose to apply the margin scheme in working out the amount of GST' if the supplier makes a taxable supply of real property. It does not expressly state when the choice to use the margin scheme needs to be made.

23. However, it is the Commissioner's view that, to be entitled to apply the margin scheme under subsection 75-5(1) prior to its amendment, the supplier must have chosen to apply the margin scheme at or before the time it makes the supply. If the choice is not made by that date, it is the Commissioner's view that it cannot be made at a later date.

24. Support for this view is found in the wording contained in Division 75. For example, the language of subsection 75-20(1) provides that an acquisition is not a creditable acquisition if the supply was a taxable supply under the margin scheme. This suggests that the choice to apply the margin scheme must have been made by the time the taxable supply was made for the supply to be a 'taxable supply under the margin scheme'.

25. Similarly, paragraph 75-25(1)(a) refers to 'a taxable supply of real property under the margin scheme' and subsection 75-30(1) refers to 'a supply of real property under the margin scheme'. These provisions appear to be founded on the assumption that it will be known that the supply is a supply under the margin scheme, which can only be the case if the supplier has chosen to apply the margin scheme by the time the supply is made.

26. However, in limited circumstances the Commissioner allows GST to be calculated as if the choice to apply the margin scheme had been made by the time the supply is made.¹⁵

¹³ The date of Royal Assent of the 2005 Amendment Act.

¹⁴ Items 9 and 10 of Schedule 6 of the 2005 Amendment Act.

¹⁵ See Law Administration Practice Statement PS LA 2005/2 (GA): GST and time of choice to apply the margin scheme.

Conditional application of the margin scheme

27. Commonly, contracts specify that there is no GST payable on a supply, but that if the supply is taxable then the GST payable will be calculated under the margin scheme. In these circumstances, the Commissioner accepts that the requirements in paragraph 75-5(1A)(a) have been satisfied.

28. Similarly, where subsection 75-5(1), prior to its amendment applies, the Commissioner accepts that the supplier has made a choice to apply the margin scheme before the supply has been made.

Supplies made before 17 March 2005 to which the margin scheme cannot be applied

29. Under the subsection 75-5(2), prior to its amendment,¹⁶ you could not apply the margin scheme if you acquired the real property through a taxable supply and the GST on the supply was not calculated under the margin scheme. The effect of the former subsection 75-5(2) was that the margin scheme could only apply if the supply of the real property that you acquired was:

- from an entity that applied the margin scheme on the supply to you; or
- not a taxable supply. For example, supplies that are GST-free or input taxed, or from an entity that was not registered or required to be registered for GST purposes.

Example 1: former subsection 75-5(2)

30. *Tureia and Phil are both registered for GST purposes. Tureia is a builder. On 20 January 2002, Phil sold Tureia a block of land for \$220,000. The sale of the land was a taxable supply, but Phil did not use the margin scheme. Instead, he accounted for GST of \$20,000 (1/11th of \$220,000) on the supply and issued Tureia with a tax invoice for the supply. Tureia intends to build a block of units on the land and sell them.*

31. *Tureia sells the units on 20 December 2004. Tureia could not use the margin scheme for the sale of the units, because she acquired the land through a taxable supply where the GST on the supply was calculated without using the margin scheme. Tureia must pay GST of 1/11th of the price for which she sells the units. She can claim an input tax credit of \$20,000 for the acquisition of the land.*

¹⁶ Subsection 75-5(2) prior to its amendment applies to supplies made before 17 March 2005.

Supplies made on or after 17 March 2005 that are ineligible for the margin scheme

32. Subsection 75-5(2) (as amended by the 2005 Amendment Act) provides that the margin scheme does not apply if you acquired the entire freehold interest, stratum unit or long-term lease through a supply that was ineligible for the margin scheme. Under subsection 75-5(3) a supply is ineligible for the margin scheme if:

- it is a taxable supply on which the GST was worked out without applying the margin scheme;
- it is a supply of real property you inherited and the deceased person acquired all of the real property through a supply that was ineligible for the margin scheme;
- it is a supply of real property and all of the following apply:
 - you acquired the real property from a fellow group member when you were a member of a GST group;
 - the fellow group member had acquired it from an entity that was not a member of the GST group; and
 - this earlier supply was not eligible for the margin scheme because of the operation of subsection 75-5(2); or
- it is a supply of real property and both of the following apply:
 - you acquired the real property from the joint venture operator of a GST joint venture¹⁷ at the time when you were a participant of a joint venture;¹⁸ and
 - the joint venture operator had acquired the real property through a supply that was ineligible for the margin scheme.

¹⁷ GST joint venture is defined in section 195-1 as having the meaning given by section 51-5. GST joint ventures are discussed in Goods and Service Tax Ruling GSTR 2004/2 Goods and services tax: what is a joint venture for GST purposes?

¹⁸ Section 195-1 defines 'participant' in relation to a GST joint venture as an entity currently approved as one of the participants of the joint venture under section 51-5 or paragraph 51-70(1)(a).

Example 2: GST groups

33. *Apex Pty Ltd made a taxable supply of land to Beta Pty Ltd for \$1.1 million without applying the margin scheme. Beta Pty Ltd is a member of a GST group but Apex Pty Ltd is not. Beta Pty Ltd sells the land to Cara Pty Ltd, another member of the GST group, for \$2.2 million. The supply from Beta Pty Ltd to Cara Pty Ltd is not a taxable supply as both entities are members of the same GST group.*¹⁹

34. *Cara Pty Ltd then makes a taxable supply of the land to Delta Pty Ltd who is not a member of the GST group.*

35. *Cara Pty Ltd cannot use the margin scheme. The supply by Cara Pty Ltd is ineligible for the margin scheme under paragraph 75-5(3)(c) because the supply between Apex Pty and Beta Ltd was a taxable supply on which the GST was worked out without applying the margin scheme.*

When do you supply or acquire real property?

36. Most legal interests in Torrens title land are created or transferred only upon registration of the relevant instrument.

37. However, because of the practical difficulties of determining precisely when the instrument is registered or lodged for registration that would arise if a literal interpretation of the law were to be taken, the Commissioner considers that Parliament would have intended that, in the context of GST, a less strict approach should apply.

38. For that reason, the Commissioner considers that for the sale of a freehold interest or stratum unit, the supply and the acquisition is made at settlement as this is when the purchaser (or the purchaser's agent) obtains:

- unconditional possession of a registrable instrument of transfer; or
- an instrument of transfer that would be registrable once stamped.

39. If the supply is made by way of sale or grant of a long-term lease, the lease is supplied and acquired when the recipient obtains a leasehold estate in the land. However, if registration of the lease or instrument of transfer is required under the State or Territory legislation applying when the lessee obtains the leasehold interest, the Commissioner considers that the lease is supplied and acquired when the recipient (or the recipient's agent) obtains:

- unconditional possession of a registrable lease or instrument of transfer of the lease; or

¹⁹ Subsection 48-40(2).

- a lease or an instrument of transfer of lease that would be registrable when it is stamped.

Again, as in the case of a sale of a freehold interest or stratum unit, this is at settlement.

Can you use the margin scheme when you supply a tenancy in common interest in real property?

40. Subsection 75-5(1) describes the types of real property that can be supplied under the margin scheme, as follows:

- (a) selling a freehold interest in land;
- (b) selling a stratum unit; or
- (c) granting or selling a long-term lease.

41. Tenancy in common is defined in Butterworth's *Australian Legal Dictionary*, 1997, as:

A type of co-ownership where two or more persons own distinct interests in the same piece of property. The tenants in common hold undivided shares, possessing the property in common and without exclusive possession of any part of it.

42. In *Nullagine Investments Pty Ltd v. Western Australian Club Inc* (1993) 177 CLR 635 at 644 Brennan J described an interest held by a tenant in common as:

The shares of tenants in common are not carved out of, or engrafted onto, some notional tenure of an estate in fee simple in the land amenable to sale by, or on the application of, one tenant. Nor are tenants in common equitable owners of land capable of compelling a sale of the legal title by a bare legal owner. The rights of ownership are exhausted by the shares of two tenants in common, each seised of and holding on his own behalf an estate in fee simple in a one half share in a parcel of land.

43. It is evident that when tenants in common acquire freehold land, each tenant has a freehold interest in the land. This will also be the case, if the tenants in common each have a freehold interest in a stratum unit. The sale of the freehold interest in either of these circumstances falls within paragraph 75-5(1)(a).

44. Similarly, if tenants in common have a leasehold interest in land or a stratum unit, the sale or grant of the leasehold interest in these circumstances falls within paragraph 75-5(1)(c).

How is the margin for the supply calculated under subsection 75-10(2)?

45. Under subsection 75-10(2), the margin for the supply is the amount by which the consideration for the supply exceeds the consideration for the acquisition of the real property.

46. If the consideration for the acquisition is equal to or greater than the consideration for the supply, then the margin for the supply is zero.

Consideration for the supply and settlement adjustments

47. The consideration for the supply and the consideration for the acquisition may be either monetary or non-monetary or both. The consideration for the supply or acquisition should take into account adjustments on settlement that are commonly made for rates, land tax and other outgoings. Goods and Services Tax Determination GSTD 2006/3²⁰ contains a detailed discussion on this topic.

Consideration for the acquisition

48. The consideration for the acquisition of the real property is the original purchase price after taking into account settlement adjustments. In the case of subdivided land or a stratum unit, the effect of section 75-15 is that the consideration for the acquisition is the corresponding proportion of the consideration for the real property that you acquired. If land that is part of the original broadacres is used for public purposes including roads, parklands or utilities ('lost land'), the acquisition consideration of the entire broadacres is apportioned to the total number of subdivided lots, so that the sum of the apportioned amounts equals the acquisition consideration for the broadacres (including the 'lost land').

49. The consideration for the acquisition does not include costs that the supplier had incurred that were associated with their purchase of the real property, such as their legal expenses and stamp duty. It also does not include costs incurred in developing the real property, prior to or after its acquisition.

Alternative view

50. The interest in real property that you acquire may differ from the interest that you supply. The most common examples of this are where you subdivide land or construct stratum units.

51. In these circumstances, the title for the interest that you supply is not created until the subdivided land or stratum unit is registered with the relevant authority. Because of this, one view of the meaning of consideration for the acquisition is that any expenditure incurred in subdividing the land or constructing the stratum unit forms part of the consideration for the acquisition. The rationale for this is that the acquisition of the interest only occurs when the interest that you supply is created.

²⁰ Goods and services tax: are settlement adjustments taken into account to determine the consideration for the supply or acquisition of real property?

52. The Commissioner does not accept this view as section 75-15 addresses circumstances where the interest that is supplied differs from the interest that was acquired. The effect of section 75-15 is that for subdivided land or stratum title units, the consideration for the acquisition is the corresponding proportion of the consideration for the land or premises that you acquired.

53. The Full Federal Court decision in *Sterling Guardian Pty Limited v. Commissioner of Taxation* [2006] FCAFC 12 confirms that costs incurred in developing real property do not form part of the consideration for the acquisition of the real property.

The effect of section 75-14 on supplies made on or after 17 March 2005

54. The treatment of excluding costs incurred in developing real property from the calculation of the margin for the supply is confirmed by section 75-14. Section 75-14 is effective from 17 March 2005.

55. Section 75-14 makes it clear that in working out the consideration for the acquisition the following are disregarded:

- (a) the cost or value of any other acquisitions that have been made by you, or any work that has been performed in relation to the real property; and
- (b) the cost or value of any other acquisitions that are intended to be made by you, or any work that is intended to be performed after you have acquired the real property,

including acquisitions or work connected with bringing the real property into existence.

Example 3: section 75-14

56. *Bob is a builder. He purchases a block of vacant land for \$180,000 and then constructs a house on the land. The cost of constructing the house is \$100,000. Bob sells the house and land package for \$400,000.*

57. *The margin for the supply is \$220,000 (\$400,000 - \$180,000). The cost of constructing the house is not part of the consideration for the acquisition of the land. Instead, Bob is entitled to input tax credits for any construction acquisitions (for example, building materials and subcontractors' services) that are creditable acquisitions.*

Apportionment methods

58. To ascertain the proportion of the purchase price that relates to the subdivided allotment or stratum unit, you may use any fair and reasonable method of apportionment. The method of apportionment used must result in the sum of the proportionate amount of the purchase price that relates to each subdivided allotment or stratum unit equalling in total, the actual consideration for the acquisition. You cannot change the method of apportionment after sales of allotments or stratum units have been made unless the changed method is applied to calculate the margin for all the sales.

59. Examples of some methods that you may use are as follows:

- *area* – the consideration for the real property acquired is apportioned on the basis of the proportion of the total saleable area of the development represented by the particular lot;
- *lots or sites* – the apportionment is based on the number of lots or sites;
- *anticipated selling price* – the consideration for the real property that you acquired is apportioned on the basis of the proportion of the total anticipated selling price of the development represented by the particular lot; and
- *total aggregated selling prices* – the consideration for the real property that you acquired is apportioned on the basis of the proportion of the total aggregated selling prices of the development represented by the particular lot. This method is only suitable for a development where all the lots are sold in a time that allows the aggregated selling prices to be calculated by the time the relevant Activity Statements are due to be lodged.

60. The methods above may be used provided they give a fair and reasonable result. Use of 'lots or sites' as an apportionment method would not give a fair and reasonable result if the size or value of the lots or sites varied significantly.

61. In some circumstances, you may use a combination of these or other fair and reasonable methods of apportionment. An example of where this may provide a fair and reasonable apportionment is a multi-staged development.

Example 4: area basis

62. Josine is a property developer who is registered for GST purposes. She acquired a block of land of 2,000 square metres for \$240,000. The block was of approximately uniform value per square metre. She subdivided the block into two allotments of 600 square metres each and one allotment of 800 square metres. As the lots are approximately of uniform value per square metre, Josine can use an area basis to ascertain the consideration for the acquisition of the subdivided allotments as it will provide a fair and reasonable result. Using this method, the consideration for the acquisition for each of the 600 square metre allotments is \$72,000 ($600/2,000 \times \$240,000$), whilst the consideration for the acquisition of the 800 square metre allotment is \$96,000 ($800/2,000 \times \$240,000$).

63. If Josine sells the 800 square metre allotment for \$140,000, the margin for the supply is \$44,000 ($\$140,000 - \$96,000$) and the GST payable on the supply is \$4,000.

Example 5: lots area

64. Neville acquires a house and land for \$500,000. Neville intends to demolish the house and construct four duplexes on the land. As each of the duplexes is of similar value Neville can use the lots method to establish the consideration for the acquisition for each of the duplexes. Using this method, the consideration for the acquisition of each duplex is \$125,000 ($1/4 \times \$500,000$).

Example 6: anticipated sales price

65. Adam is a builder who is registered for GST purposes. He acquires land for \$400,000. He subdivides the land and builds a house on each allotment. As the quality of the land varies between allotments, the anticipated sales method will provide a fair and reasonable apportionment method to ascertain the consideration for the acquisition for each of the house and land packages.

66. The anticipated sales price for each of the house and land packages and the consideration for the acquisition of each of them is shown below.

Lot no.	Anticipated sales price	Consideration for the acquisition <u>anticipated sales price</u> × \$400,000 total anticipated sales prices
1	\$200,000	\$40,000
2	\$200,000	\$40,000
3	\$300,000	\$60,000
4	\$300,000	\$60,000
5	\$500,000	\$100,000
6	\$500,000	\$100,000
Total	\$2,000,000	\$400,000

67. Adam subsequently sells Lot 1 for \$190,000. The margin for the supply of Lot 1 is \$150,000 (\$190,000 - \$40,000). The GST payable on the supply is \$13,636.36 (1/11 of \$150,000).

Example 7: multi-staged developments

68. Johanna purchases land for \$1.5 million which she intends to subdivide in three stages. As the land is of approximately uniform value per square metre, Johanna initially apportions the \$1.5 million on an area basis between the three stages, giving values of \$500,000 for stage one, \$600,000 for stage two and \$400,000 for stage three. When stage one is developed, Johanna can apportion the \$500,000 acquisition consideration attributed to stage one between the allotments on an anticipated sales price basis provided this method gives a fair and reasonable result.

The effect of section 75-11 on supplies made on or after 17 March 2005

69. The margin for the supply is not calculated under subsection 75-10(2) if the circumstances in subsection 75-11 apply, as subsection 75-10(2) is subject to the operation of section 75-11.

70. Section 75-11 applies to supplies made on or after 17 March 2005, and applies if real property was acquired from:

- a fellow member of a GST group (GST group);
- a joint venture operator of a GST joint venture (GST joint venture);
- a deceased estate (deceased estate); and
- an associate (associate).

71. If more than one of these circumstances apply, the margin is worked out as follows:

Subsections	Description of acquisition	When do the subsections apply?
Subsections 75-11(1) and (2)	GST group	Subsections 75-11(1) and (2) apply regardless of whether the circumstances in subsections 75-11(3) and (7) apply.
Subsections 75-11(2A) and (2B)	GST joint ventures	Subsections 75-11(2A) and (2B) apply regardless of whether the other subsections apply.
Subsections 75-11(3) and (4)	Deceased estates	Subsections 75-11(3) and (4) will only apply if subsections 75-11(1) to (2B) do not apply.
Subsection 75-11(7)	Associates	Subsection 75-11(7) will only apply if the other subsections in section 75-11 do not apply.

Supply of real property made on or after 17 March 2005 if the acquisition is from a fellow member of a GST group

Subsection 75-11(1)

72. For GST groups, subsection 75-11(1) deals with working out the margin for the supply if:

- you are a member of a GST group and you make a supply of real property to an entity that is not a member of the GST group (the non-GST group member);
- you acquired the real property from another member of the GST group;
- on or after 1 July 2000 there had been an earlier supply of the real property and the supplier was not a member of the GST group; and
- the recipient of this earlier supply was a member of the GST group, or subsequently became a member of the GST group.

73. If these circumstances apply, the margin for your supply to the non-GST group member is worked out under either paragraph 75-11(1)(c) or (d).

Paragraph 75-11(1)(c)

74. Paragraph 75-11(1)(c) applies in working out the GST on your supply to the non-GST group member, if the real property was acquired by an entity that was a GST group member (or subsequently became one) from an entity that was not:

- its associate; or
- a member of the GST group.

75. Under paragraph 75-11(1)(c), the margin for the supply is the amount by which the consideration for the supply you make to the non-GST group member exceeds the consideration for the real property acquired by the GST group member. This means that supplies between group members are effectively disregarded.

Example 8: GST groups where earlier supply made on or after 1 July 2000

76.

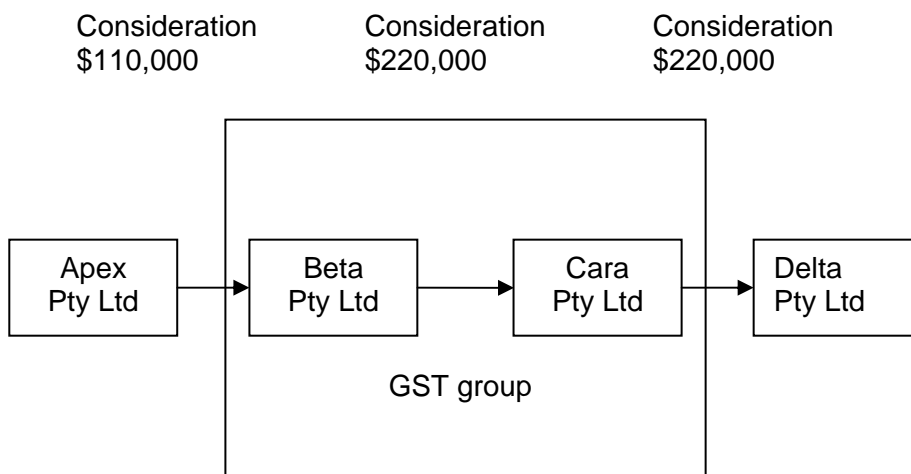

NB: The supply by Apex Pty Ltd to Beta Pty Ltd was made on or after 1 July 2000.

77. In the context of the diagram above, the margin for the supply by Cara Pty Ltd to Delta Pty Ltd is the difference between the consideration for the supply of \$220,000 and the consideration for the acquisition by Beta Pty Ltd of \$110,000. The supply by Beta Pty Ltd to Cara Pty Ltd is effectively disregarded when working out the margin for the supply by Cara Pty Ltd.

78. In the diagram, Beta Pty Ltd was a member of the GST group when it acquired the real property. However, subsection 75-11(1) would also apply if Beta Pty Ltd was not a member of the GST group when it acquired the real property, but became a member of the GST group by the time Cara Pty Ltd made its supply to Delta Pty Ltd.

Paragraph 75-11(1)(d)

79. Paragraph 75-11(1)(d) applies in working out the GST on your supply to the non-GST group member, if the real property was acquired by an entity that was a GST group member (or subsequently became one) from an associated entity²¹ that was not a member of the GST group.

²¹ 'Associate' is defined in section 195-1 as having the meaning given by section 318 of the *Income Tax Assessment Act 1936*.

GSTR 2006/8

80. Under paragraph 75-11(1)(d), the margin is the amount by which the consideration for the supply you make to the non-GST group member exceeds the GST-inclusive market value of the real property at the time of the last earlier supply. The supplies between group members are disregarded.

Example 9: GST groups and associates where earlier supply made on or after 1 July 2000

81.

Consideration \$220,000 (but the GST-inclusive market value is \$110,000)	Consideration \$330,000	Consideration \$330,000
---------------------------------------------------------------------------------------	----------------------------	----------------------------

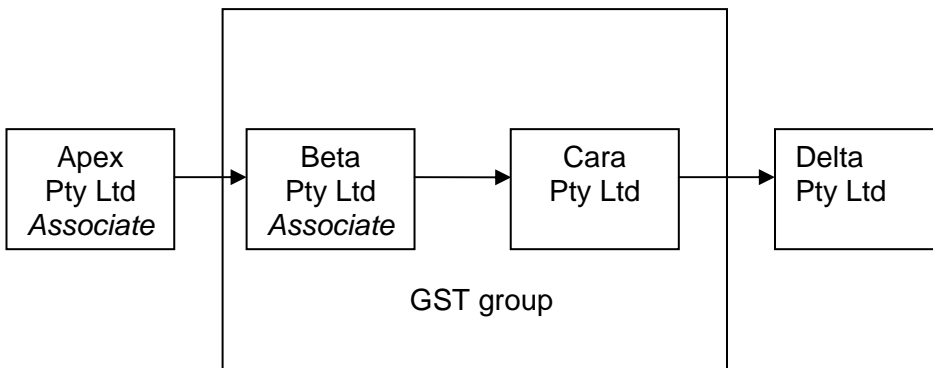

NB: The supply by Apex Pty Ltd to Beta Pty Ltd was made on or after 1 July 2000.

82. In the context of the diagram above, the margin for the supply by Cara Pty Ltd to Delta Pty Ltd is the difference between the consideration for the supply of \$330,000 and the GST-inclusive market value of the real property of \$110,000 at the time of the acquisition by Beta Pty Ltd. The supply by Beta Pty Ltd to Cara Pty Ltd is effectively disregarded when working out the margin for the supply by Cara Pty Ltd.

83. In the diagram Beta Pty Ltd was a member of the GST group when it acquired the real property. However, subsection 75-11(1) would also apply if Beta Pty Ltd was not a member of the GST group when it acquired the real property, but later became a member of the GST group.

Subsection 75-11(2)

84. Subsection 75-11(2) deals with working out the margin if:

- you are a member of a GST group and you make a supply of real property to an entity that is not a member of the GST group (the non-GST group member);
- you acquired the real property from another member of the GST group;
- before 1 July 2000 there had been an earlier supply and the recipient of this earlier supply subsequently became a member of the GST group; and
- subsection 75-11(1) does not apply.

85. Under subsection 75-11(2), the margin for the supply you make is the amount by which the consideration for the supply to the non-GST group member exceeds an approved valuation of the real property as at 1 July 2000. Approved valuations are discussed at paragraphs 115 to 128.

Example 10: GST group where earlier supply made before 1 July 2000

86.

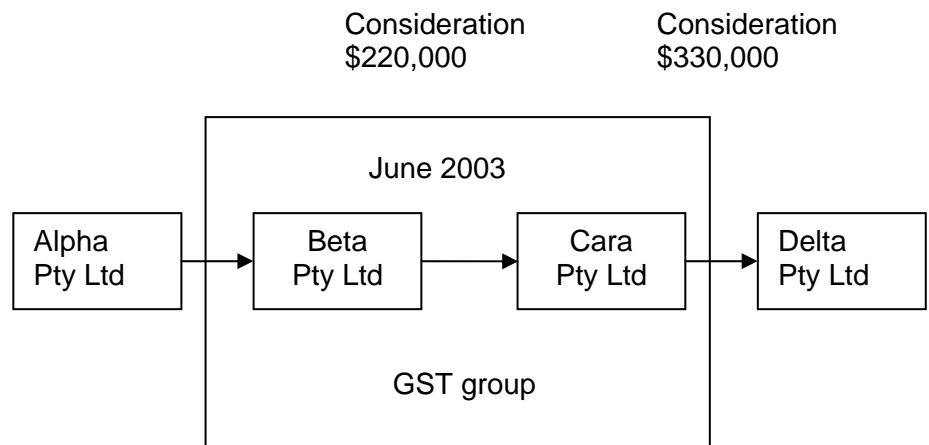

NB: The supply to Beta Pty Ltd was made before 1 July 2000. The approved valuation as at 1 July 2000 is \$110,000.

87. In the context of the diagram above, the margin for the supply by Cara Pty Ltd to Delta Pty Ltd is \$220,000, being the difference between the consideration for the supply of \$330,000 and the approved valuation of the real property as at 1 July 2000 of \$110,000. The supply between Beta Pty Ltd and Cara Pty Ltd in June 2003 is effectively disregarded.

Supply of real property made on or after 17 March 2005 where the real property was acquired from a joint venture operator

88. Subsection 75-11(2A) applies if the joint venture operator acquired the real property on or after 1 July 2000, while subsection 75-11(2B) applies if the joint venture operator acquired the property before that date.

Subsection 75-11(2A)

89. Subsection 75-11(2A) applies if you make a supply of real property under the margin scheme and all of the following apply:

- a joint venture operator had acquired the real property on or after 1 July 2000 (it does not matter if the joint venture operator was not a joint venture operator when the real property was acquired);
- the joint venture operator supplied the real property to you when you were a participant of the GST joint venture;
- you acquired the real property for consumption, use or supply in the course of the joint venture activities; and
- subsection 51-30(2) applied to treat the supply of the real property to you as if it were not a taxable supply.²²

90. If the joint venture operator acquired the real property from an entity that was not an associate at the time of the acquisition then under paragraph 75-11(2A)(d) the margin for the supply of the real property is the amount by which the consideration for the supply you make exceeds the consideration for the supply to the joint venture operator. This means that supplies between the joint venture operator and the participants of the GST joint venture are effectively disregarded.

²² A detailed discussion of joint ventures is contained in GSTR 2004/2 Goods and services tax: What is a joint venture for GST purposes. GSTD 2004/2 Goods and services tax: Are all supplies made by the entity nominated as the joint venture operator to entities that are participants in the GST joint venture to be treated as if they are not taxable supplies?

91. If the joint venture operator acquired the real property from an entity that was an associate at the time of the acquisition, then under paragraph 75-11(2A)(e), the margin for the supply of the real property is the amount by which the consideration for the supply you make exceeds the GST inclusive market value of the real property at the time that the joint venture operator acquired the real property.

Subsection 75-11(2B)

92. Subsection 75-11(2B) applies if you make a supply of real property under the margin scheme and all of the following apply:

- you were a participant of a GST joint venture and the joint venture operator supplied the real property to you;
- you acquired the real property for consumption, use or supply in the course of the joint venture activities;
- subsection 51-30(2) applied to treat the supply of the real property to you as if it were not a taxable supply; and
- subsection 75-11(2A) does not apply.

93. If subsection 75-11(2B) applies, the margin for the supply you make is the amount by which the consideration for the supply exceeds an approved valuation of the real property as at 1 July 2000. Approved valuations are discussed at paragraphs 115 to 132.

Supply of real property made on or after 17 March 2005 where the acquisition was from a deceased estate

94. Subsections 75-11(3) and (4) address how the margin scheme works when you supply real property that you acquired through inheriting it. Section 195-1 specifies the manner in which real property can be inherited. It states that you inherit a freehold interest in land, a stratum unit or a long-term lease if you become an owner of the interest, unit or lease:

- (a) under the will of a deceased person, or that will as varied by a court order;
- (b) by operation of an intestacy law, or such a law as varied by a court order;
- (c) because it is appropriated to you by the legal personal representative of a deceased person in satisfaction of a pecuniary legacy or some other interest or share in the deceased person's estate; or
- (d) under a deed of arrangement if:
 - (i) you entered into the deed to settle a claim to participate in the distribution of the deceased person's estate; and

- (ii) any consideration given by you for the interest, unit or lease consisted only of the variation or waiver of a claim to one or more other assets that formed part of the estate.

95. Subsection 75-11(3) applies if the deceased acquired the real property before 1 July 2000, while subsection 75-11(4) applies if the deceased acquired the property on or after that date. Both these subsections only apply if subsections 75-11(1) to (2B) do not apply (GST groups and GST joint ventures).

96. If you supply real property that you inherit, and the deceased acquired it before 1 July 2000, then paragraph 75-11(3)(ca) allows you to choose to use the consideration for the deceased's acquisition of the real property when calculating the margin for the supply. However, paragraph 75-11(3)(ca) can only apply if:

- you know the amount of the consideration for the deceased's acquisition of the property; and
- you choose to use this amount when calculating the margin for the supply.

97. Under paragraph 75-11(3)(ca) the margin for the supply is the amount by which consideration for the supply you make exceeds the consideration for the deceased's acquisition of the property.

98. If you do not know the consideration for the deceased's acquisition of the real property, or you do not choose to calculate the margin for the supply under paragraph 75-11(3)(ca), then the margin is calculated under paragraph 75-11(3)(d) or 75-11(3)(e).

Paragraph 75-11(3)(d)

99. Paragraph 75-11(3)(d) applies if the margin for the supply is not calculated under paragraph 75-11(3)(ca) and immediately before the time that you inherited the real property, the deceased was neither registered or required to be registered for GST purposes. If paragraph 75-11(3)(d) applies, the margin for the supply is the amount by which the consideration for the supply exceeds an approved valuation of the real property as at the latest of:

- (i) 1 July 2000;
- (ii) the day on which you inherited the real property; or
- (iii) the first day on which you were registered or required to be registered for GST purposes.

100. It is evident from paragraph 6.29 of the Revised Explanatory Memorandum to the Tax Laws Amendment (2005 Measures No. 2) Bill 2005 that Parliament's intention is that the day on which you inherited the real property will ordinarily be the date of death of the deceased.²³ However, in some circumstances such as where a will is varied by a court order or the beneficiaries of the estate enter into a deed of arrangement, then the day on which you inherited the real property will be the date the court order or deed of arrangement becomes effective.

Paragraph 75-11(3)(e)

101. Paragraph 75-11(3)(e) applies if the margin for the supply is not calculated under paragraph 75-11(3)(ca) and immediately before the time that you inherited the real property, the deceased was registered or required to be registered for GST purposes. Under paragraph 75-11(3)(e) the margin for the supply is the amount by which the consideration for the supply exceeds an approved valuation of the real property as at the latest of:

- (a) 1 July 2000; or
- (b) the first day on which the deceased registered or was required to be registered for GST purposes.

Subsection 75-11(4)

102. If you supply real property that you inherit, and the deceased acquired it on or after 1 July 2000, then paragraph 75-11(4)(d) allows you to choose to use the consideration for the deceased's acquisition of the real property when calculating the margin for the supply. However, paragraph 75-11(4)(d) can only apply if:

- you know the amount of the consideration for the deceased's acquisition of the property; and
- you choose to use this amount when calculating the margin for the supply.

103. Under paragraph 75-11(4)(d) the margin for the supply is the amount by which consideration for the supply you make exceeds the consideration for the deceased's acquisition of the property.

104. If you do not know the consideration for the deceased's acquisition of the real property, or you do not choose to use that consideration, then the margin for the supply is calculated under paragraph 75-11(4)(e).

²³ Paragraph 6-29 of the Revised Explanatory Memorandum to the Tax Laws Amendment (2005 Measures No. 2) Bill 2005 states that 'in most cases the day on which you inherit property is the date of death of the deceased'.

105. Under paragraph 75-11(4)(e) the margin for the supply is the amount by which the consideration for the supply exceeds an approved valuation of the real property as at the day that the deceased acquired it.

Supply of real property made on or after 17 March 2005 where the real property was acquired from an associate

106. If you supply real property that you acquired on or after 1 July 2000 from an entity that was your associate²⁴ at the time of acquisition, the margin for the supply is worked out under paragraph 75-11(7)(d),²⁵ provided that the other subsections in section 75-11 do not apply.

107. Under paragraph 75-11(7)(d), the margin is the amount by which the consideration for the supply exceeds the GST inclusive market value of the real property at the time of its acquisition.

Example 11: real property acquired from an associate

108.

Consideration \$490,000 28 June 2005	Consideration \$500,000 14 July 2006
--------------------------------------------	--------------------------------------------

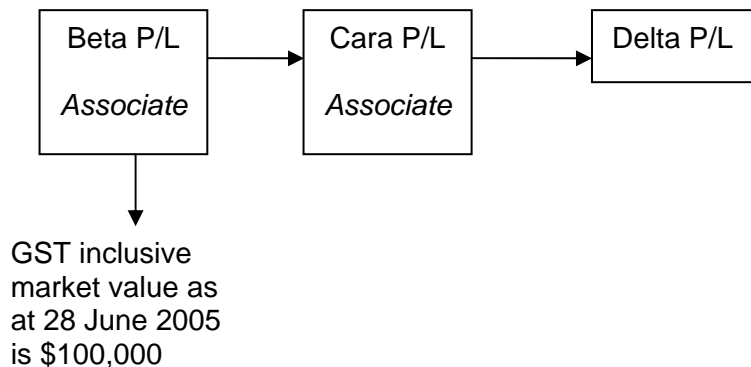

²⁴ 'Associate' is defined in section 195-1 as having the meaning given by section 318 of the *Income Tax Assessment Act 1936*.

²⁵ Paragraph 75-11(7)(c) applies to supplies of real property that you acquired before 1 July 2000 from an entity that was your associate at the time of acquisition. This is discussed in GSTR 2006/7 at paragraph 56.

109. The margin for the supply by Cara Pty Ltd to Delta Pty Ltd is the amount by which the consideration for the supply exceeds the GST inclusive market value of the real property at the time of acquisition from Beta Pty Ltd. That is:

$$\begin{aligned}\text{Margin} &= \$500,000 - \$100,000 \\ &= \$400,000\end{aligned}$$

Subsection 75-11(8)

110. Subsection 75-11(8) extends the application of subsection 75-11(7) to acquisitions through supplies made by the following:

- a GST branch;
- a non-profit sub-entity;
- a government entity of a kind referred to in section 72-95 or 72-100;

in the same way as Subdivision 72-D affects the operation of Division 72.

111. The effect of this is that subsection 75-11(7) applies not only to associates as defined in section 195-1 but also treats the following as if they were associates:

- (a) a GST branch of an entity as if it were an associate of:
 - that entity;
 - every other GST branch of that entity; and
 - any other associate of that entity;
- (b) a non-profit sub-entity of an entity as if the non-profit sub-entity was an associate of:
 - that entity;
 - every other non-profit sub-entity of that entity; and
 - any other associate of that entity; and
- (c) a government entity that is:
 - a Department of State of the Commonwealth;
 - a Department of the Parliament;
 - an Executive Agency, or Statutory agency, within the meaning of the *Public Service Act 1999*; or

- an organisation, established by the Commonwealth, of a kind referred to in paragraph (e) of the definition of government entity in section 41 of the *A New Tax System (Australian Business Number) Act 1999*;

as if the government entity were an associate of the Commonwealth, of every other government entity of a kind referred to in paragraph (i), (ii), (iii) or (iv) and of any other associate of the Commonwealth.

Supply of real property to an associate where the supply is made on or after 17 March 2005

112. If you supply real property to an associate, section 75-13 deems the consideration for the supply to be the GST-inclusive market value of the real property at the time of the supply.

Example 12: supplies to associates

113.

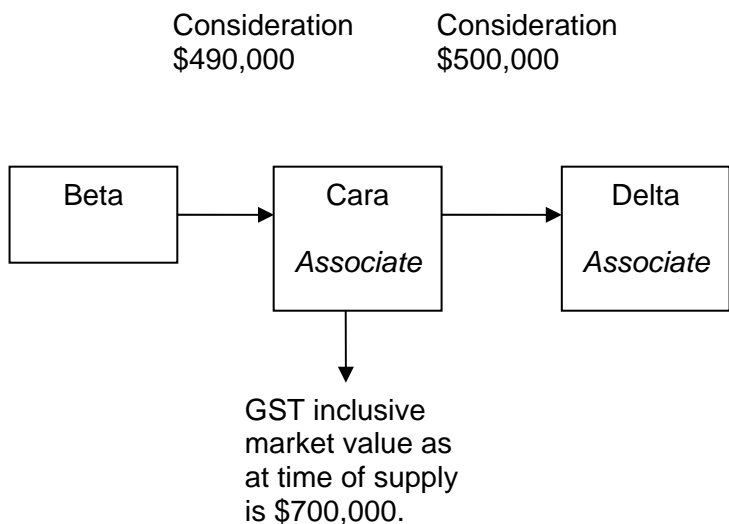

114. The GST inclusive market value of the supply at the time of the supply is treated as the consideration for the supply from Cara Pty Ltd to Delta Pty Ltd. The margin for the supply by Cara Pty Ltd to Delta Pty Ltd is the amount by which the 'deemed' consideration for the supply exceeds the consideration for the acquisition by Cara Pty Ltd. That is:

$$\begin{aligned} \text{Margin} &= \$700,000 - \$490,000 \\ &= \$210,000 \end{aligned}$$

Approved valuations

115. Section 75-35 applies to supplies made on or after 17 March 2005. It provides that the Commissioner may by legislative instrument 'determine in writing requirements for making valuations' for the purposes of the margin scheme.

116. A legislative instrument, MSV 2005/1, was registered on 16 March 2005. It applies to supplies made between 17 March 2005 and 30 November 2005 inclusive. Under this Determination, the valuation may be determined in writing by a professional valuer. Section 75-35 is effective from 17 March 2005. As this Determination was made prior to section 75-35 being enacted it was made under paragraph 75-10(3)(b) of the GST Act.

117. MSV 2005/3 was registered on 9 September 2005. It replaces MSV 2005/1, and applies to supplies of real property made on or after 1 December 2005 and before 1 March 2010.²⁶

117A. MSV 2009/1 was registered on 20 October 2009. It replaces MSV 2005/3, and applies to supplies of real property made on or after 1 March 2010.^{26A} (MSV 2009/1 also includes a new method 4 which applies to certain taxable supplies acquired before 1 July 2001.)^{26B}

118. MSV 2005/3 and MSV 2009/1 set out the requirements as determined by the Commissioner for the following valuation methods:

- (a) a valuation by a professional valuer (Method 1);
- (b) a valuation based on the consideration provided by a purchaser (that is, received by the supplier) under the contract of sale (Method 2); and
- (c) a State or a Territory Government department valuation (Method 3).

118A. The requirements for each of these valuation methods are discussed at paragraphs 118B to 118F of this Ruling and paragraphs 73 to 82 of Goods and Services Tax Ruling GSTR 2006/7.^{26C}

²⁶ MSV 2005/3 replaces *A New Tax System (Goods and Services Tax) Margin Scheme Valuation Requirements Determination (No. 1) 2000* and the *A New Tax System (Goods and Services Tax) Margin Scheme Valuation Requirements Determination (No. 2) 2000*. Both of these determinations applied when the margin for the supply was calculated under paragraph 75-10(3)(b). It does not replace *A New Tax System (Goods and Services Tax) Margin Scheme Valuation Requirements Determination MSV 2005/2*.

^{26A} MSV 2009/1 does not replace MSV 2005/2 which applies to taxable supplies of real property made on or after 1 July 2005 under contracts entered into before 1 July 2005.

^{26B} Refer to paragraphs 70A, 70B and 82A to 82H of GSTR 2006/7.

^{26C} Goods and services tax: how the margin scheme applies to a supply of real property made on or after 1 December 2005 that was acquired or held before 1 July 2000.

Method 1: valuation of the market value determined by a professional valuer

118B. The requirements for method 1 are the same under both MSV 2005/3 and MSV 2009/1.

118C. For a valuation by a professional valuer to be an approved valuation for the purposes of Division 75, that valuation must be made in accordance with the requirements specified in the determination. The valuation is the market value of the interest, unit or lease that you held at the valuation date (or, if item 2A applies, the interest you acquired on or after the valuation date) as determined in writing by a professional valuer, provided it is not contrary to professional standards recognised in Australia.

Method 2: valuation based on the consideration provided by a purchaser (that is, received by the supplier) under the contract of sale

118D. The requirements set out under Method 2 in MSV 2005/3 refer to a valuation based on the *consideration provided by a purchaser* in a contract for the sale and purchase of real property. MSV 2009/1 merely rewords the requirements in MSV 2005/3 in terms of the *consideration received by the supplier* so that it is immediately clear that this method is not the same as the consideration method under subsection 75-10(2).

118E. For a valuation based on the sale contract price to be an approved valuation for the purposes of Division 75, that valuation must be made by adopting as the valuation the consideration provided by a purchaser (that is, received by the supplier) under the contract of sale of the real property that has been executed or exchanged before the valuation date between parties dealing at arm's length.^{27A}

Method 3: State Government or Territory Government department valuation

118F. The requirements set out under method 3 in MSV 2005/3 refer to a valuation based on the most recent unimproved value, site value, or the capital value of the land for rating or land tax purposes before the valuation date. Method 3 in MSV 2009/1 omits the words 'unimproved value, site value, or the capital value'. This clarifies that a valuation made by or on behalf of a State or a Territory Government department for rating or land tax purposes is eligible as an approved valuation under Method 3 regardless of how the valuation may be described under the relevant State or Territory legislation.

^{27A} Judicial interpretation of the phrase 'dealing at arm's length' can be found in *Collis v. FC of T* (1996) 33 ATR 438; 96 ATC 4831, *Granby v. FC of T* (1995) 30 ATR 400; 95 ATC 4240; (1995) 129 ALR 503, *Barnsdall v. FC of T* (1988) 19 ATR 1352; 88 ATC 4565, *The Trustee of the Estate of the Late AW Furse No. 5 Will Trust* (1990) 21 ATR 1123; 91 ATC 4007.

119. The effect of subsection 75-35(2) is that a valuation made in accordance with the requirements in the determination is an approved valuation.

Valuation dates

120. Valuations are required to work out the margin for supplies of real property in particular circumstances under section 75-11. The table below sets out the valuation dates for the purposes of section 75-11.

Section	Description	Valuation date
75-11(2)	Supply of real property acquired from a fellow member of a GST group. ²⁷	1 July 2000.
75-11(2B)	Supply of real property acquired from a joint venture operator of a GST joint venture. ²⁸	1 July 2000
75-11(3)(d)	Supply of real property you inherited and the deceased acquired it before 1 July 2000 and immediately before the time that you inherited the real property, the deceased was not registered or required to be registered for GST purposes. ²⁹	The latest of: <ul style="list-style-type: none"> • 1 July 2000; • the day that you inherited the real property; or • the first day that you were registered or were required to be registered.
75-11(3)(e)	Supply of real property you inherited and the deceased acquired it before 1 July 2000 and immediately before the time that you inherited the real property, the deceased was registered or required to be registered for GST purposes. ³⁰	The later of: <ul style="list-style-type: none"> • 1 July 2000; or • the first day that deceased was registered or was required to be registered.
75-11(4)	Supply of real property you inherited and the deceased acquired it on or after 1 July 2000. ³¹	The day that the deceased acquired the real property.

²⁷ Supplies of real property you acquired from a GST group member are addressed at paragraphs 84 to 87.

²⁸ Supplies of real property you acquired from a joint venture operator of a GST joint venture are addressed at paragraphs 92 to 93.

²⁹ Supplies of real property you acquired as an inheritance where the deceased acquired the property before 1 July 2000 and, immediately before the time that you inherited the real property the deceased, was not registered or required to be registered for GST are addressed at paragraphs 99 to 100.

³⁰ Supplies of real property you acquired as an inheritance where the deceased acquired the property before 1 July 2000 and immediately before the time that you inherited the real property the deceased was registered or required to be registered for GST are addressed at paragraph 101.

³¹ Supplies of real property you acquired as an inheritance where the deceased acquired the property on or after 1 July 2000 are addressed at paragraphs 102 to 105.

Time to make valuations

121. To work out the margin for the supply of real property, you require a valuation as at the valuation date. The valuation process itself does not have to be undertaken on that date.

122. The valuation must be made by the due date for lodgment of the supplier's Activity Statement for the tax period to which the GST on the supply is attributable, unless paragraph 123, 123A or 124 of this Ruling applies.

123. If the Commissioner has allowed a further period under paragraph 75-5(1A)(b) for the supplier and the recipient to agree in writing that the margin scheme is to apply in working out the GST on the supply, under MSV 2005/3, the valuation must be made by the later of:

- (i) six weeks from the further period that the Commissioner has allowed under paragraph 75-5(1A)(b); or
- (ii) six weeks from the date of the Commissioner's decision to extend the further period under paragraph 75-5(1A)(b).

123A. Under MSV 2009/1, the time by which the valuation must be made has been extended by two weeks in recognition that this is a more realistic timeframe. The valuation must be made by the later of:

- (i) eight weeks from the further period that the Commissioner has allowed under paragraph 75-5(1A)(b); or
- (ii) eight weeks from the date of the Commissioner's decision to extend the further period under paragraph 75-5(1A)(b).

124. If the valuation is not undertaken within the time periods specified in paragraphs 122 to 123A of this Ruling, the Commissioner may for good reason allow an additional period to obtain a valuation.³²

125. The time periods mentioned in paragraphs 122 to 124 for obtaining valuations do not affect the date by which the choice or agreement to apply the margin scheme must be made – see paragraphs 18 to 28.

What is the real property that you value?

126. If any of the provisions of section 75-11 require you to obtain an approved valuation, the real property that you value is the real property that is in existence at the valuation date. This will not always be the real property that is supplied.

³² Refer to clauses 15 to 17 of MSV 2005/3 and clauses 21 to 23 of MSV 2009/1. Law Administration Practice Statement PS LA 2005/16 sets out the circumstances when the Commissioner may exercise the discretion contained in the Determination to extend the period for obtaining a valuation.

127. Often the real property that is supplied was not in existence at the valuation date. Examples of this are:

- land that is acquired as broadacres and is later subdivided and sold; and
- land on which strata units (or group title) are built.

128. If the real property that is supplied was not in existence at the valuation date but is part of the real property that was in existence at that date, the valuation must be made as follows:

- (a) a valuation of the real property in existence at the valuation date; and
- (b) the valuation of the real property is apportioned on any fair and reasonable basis, to ascertain the part of the valuation that relates to the real property that you supplied. If the professional valuation method is used, it is not necessary for the apportionment to be made by a professional valuer.

Example 13: valuing real property that is subdivided after the valuation date

129.

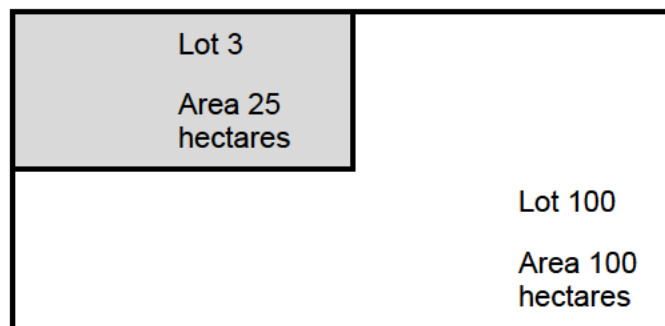

- At 1 July 2000, Lot 100 with an area of 100 hectares had a market value of \$100,000. After 1 July 2000, Lot 100 was subdivided creating Lot 3 with an area of 25 hectares.
- The value of Lot 3 is the proportion of the valuation of the interest you acquired that is in existence as at 1 July 2000, that is, Lot 100. In the context of the diagram above, this proportion is \$25,000 (1/4 of \$100,000 on the assumption that the land is of approximately uniform value per square metre).

Professional valuers

130. A professional valuer³³ is:

- (a) a person registered or licensed to carry out real property valuations under a Commonwealth, State or Territory law;
- (b) a person who carries on business as a valuer in a State or Territory where that person is not required to be licensed or registered to carry on a business as a valuer; or
- (c) a member of the Australian Property Institute who is accredited as a Certified Practising Valuer.

You may use an in-house employee who is a professional valuer.

130A. In MSV 2009/1, the definition of a professional valuer also includes:

- a member of the Royal Institution of Chartered Surveyors and accredited as a Chartered Valuation Surveyor; and
- a member of the Australian Valuers Institute and accredited as a Certified Practising Valuer.^{34A}

130B. Although members of the Royal Institution of Chartered Surveyors or Australian Valuers Institute are not specifically referred to in the definition of 'professional valuer' in MSV 2005/3, they would have been covered by paragraphs (a) and (b) of the definition above. To make this clear, MSV 2009/1 specifically includes members of these bodies in the definition of 'professional valuer'.

131. A supplier may engage a professional valuer to undertake the valuation or accept a valuation made by a professional valuer commissioned by another party, for example, a purchaser.

Documentation that a professional valuer is required to provide

132. For supplies of real property made on or after 1 December 2005, clause 10 of MSV 2005/3 and subclause 13(5) of MSV 2009/1 state that the valuation must include a signed certificate which specifies:

- (a) a full description of the property being valued;
- (b) the applicable valuation date (refer to the table in paragraph 120 of this Ruling);
- (c) the date the valuer provides the valuation to the supplier;
- (d) the market value of the property at the valuation date;

³³ The term 'professional valuer' is defined in clause 18 of MSV 2005/3.

^{34A} The term 'professional valuer' is defined in clause 23 of MSV 2009/1.

- (e) the valuation approach and the valuation calculation;
and
- (f) the name and qualifications of the valuer.^{34B}

Can you apply the margin scheme when you make a supply of real property that has separately identifiable taxable and non-taxable (that is, GST-free or input taxed) parts?

133. If a supply of real property is a mixed supply because it has separately identifiable taxable and non-taxable (that is, GST-free or input taxed) parts, then the margin scheme can apply to the taxable component. Examples of supplies that may be mixed supplies are a supply of a building that contains areas that are input taxed residential premises and taxable commercial premises or a supply of a building that includes new residential premises as well as an area supplied as a GST-free supply of a going concern.

134. In these circumstances, if the margin for the supply is calculated under subsection 75-10(2), the consideration for the supply and the consideration for the acquisition, are the amounts of the consideration that relate to the taxable component of the supply.

135. If the circumstances in section 75-11 apply, the margin is the amount by which the consideration for the supply exceeds an approved valuation or the GST-inclusive market value of the real property as the case may be.

136. You may use any fair and reasonable method of apportionment to ascertain the consideration for the supply and either

- the consideration for the acquisition;
- an approved valuation; or
- the GST-inclusive market value

that relates to the taxable component of the supply.

Approved valuation

137. The table in paragraph 120 specifies when an approved valuation is required to work out the margin for the supply.

138. If an approved valuation is required to work out the margin for the taxable component of a supply, the valuation is to be obtained for the entire real property supplied. The valuation is then apportioned on any fair and reasonable basis to ascertain the part of the valuation that relates to the taxable component of the supply.

^{34B} The requirements set out under Method 1 in MSV 2005/3 do not specifically require the name of the valuer on the signed certificate, but this requirement is implied.

GST inclusive market value

139. Paragraphs 75-11(1)(d), 75-11(2A)(e) and 75-11(7)(d) require the margin to be worked out by reference to the GST inclusive market value of the real property supplied.

140. Paragraph 75-11(1)(d) applies when a member of a GST group acquires real property on or after 1 July 2000 from an entity that is not a member of the GST group but is an associate of the GST group member.

141. Paragraph 75-11(2A)(e) applies if the joint venture operator acquired the real property from an entity that was an associate at the time of the acquisition.

142. Paragraph 75-11(7)(d) applies if you supply real property that you acquired on or after 1 July 2000 from an entity that was your associate at the time of acquisition.

143. If the GST inclusive market value is required to work out the margin for the taxable component of a supply, the GST-inclusive market value is to be obtained for the entire real property supplied. The GST inclusive market value is then apportioned on any fair and reasonable basis to ascertain the part that relates to the taxable component of the supply.

How do you calculate the GST inclusive sale price and the margin?

144. For the purposes of Division 75 the GST inclusive sale price is the GST exclusive price plus the GST payable on the margin. The following example sets out how to calculate the GST inclusive price when initially only the GST exclusive price is known.

Example 14: where only the GST exclusive price is known

145. The GST exclusive price is \$96,364 and the consideration for the acquisition is \$60,000. The GST inclusive price is calculated using the formula:

$$\text{GST inclusive price} = \frac{(E - C)}{10} + E$$

Where:

E is the GST exclusive price; and

C is the supplier's consideration for the acquisition.

$$\text{GST inclusive price} = \frac{(96,364 - 60,000)}{10} + 96,364$$

$$= \$100,000$$

$$\text{The margin for the supply} = \$100,000 - \$60,000$$

$$= \$40,000.$$

146. If the margin for the supply is calculated using an approved valuation or the GST inclusive market value the same equation is used. However, C in the equation will be the approved valuation or the GST inclusive market value.

Increasing adjustments for supplies made on or after 17 March 2005, where part of the acquisition was ineligible for the margin scheme

Subsection 75-22(1)

147. You may apply the margin scheme to the supply of real property even though you acquired part of the real property through a supply that was ineligible for the margin scheme. An example of this is where a supplier acquires two adjoining properties and one of the properties was acquired as a taxable supply without using the margin scheme, and the other property was acquired as:

- a taxable supply using the margin scheme; or
- an input taxed, GST-free or non taxable supply.³⁴

148. If you apply the margin scheme to a later supply of real property acquired in this manner, you have an increasing adjustment under subsection 75-22(1). The increasing adjustment is an amount equal to the previously attributed input tax credit amount³⁵ for the acquisition of the real property that was acquired as a taxable supply without using the margin scheme.

149. Subsection 75-22(1) applies to supplies made on or after 17 March 2005 and may apply to:

- the subdivision of broadacres; or
- construction of stratum units.

Subdivision of broadacres

150. If you acquire adjoining properties, one of which is acquired through a supply that is ineligible for the margin scheme, and you subdivide the properties, the margin scheme can be used for the supply of some of the subdivided lots.

151. The margin scheme:

- cannot be applied for the supply of those lots that were derived *entirely* from land that was acquired through a supply that was ineligible for the margin scheme as subsection 75-5(2) applies;

³⁴ A non-taxable supply is a supply that is not taxable, GST-free or input taxed. A common example is a supply by an entity that is not registered for GST purposes.

³⁵ Previously attributed input tax credit amount has the meaning given by section 19-75.

GSTR 2006/8

- can be applied to those lots derived partly from land that was acquired through a supply that that was ineligible for the margin scheme as subsection 75-5(2) does not apply. However, you have an increasing adjustment to the extent of the input tax credit entitlement for the acquisition of these lots; and
- can be applied for the supply of those lots that were derived *entirely* from land that was acquired through a supply that was eligible for the margin scheme.

Example 15: subdivision of broadacres

152. This is diagrammatically represented below as:

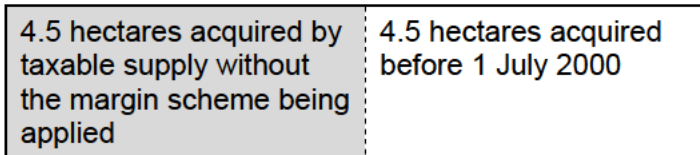

- The land is then subdivided into 9 one hectare blocks.

1	4	7
2	5	8
3	6	9

↑	↑	↑
Ineligible for margin scheme.	Margin scheme applies but there is an increasing adjustment to extent of input tax credits claimed.	Margin scheme applies.

153. In the context of the diagram, the real property that would have been ineligible for the margin scheme is shaded.

154. The margin scheme cannot apply to supplies of Lots 1 to 3 as they were acquired *entirely* through a supply that was ineligible for the margin scheme under subsection 75-5(2). The margin scheme can apply to Lots 7 to 9 because subsection 75-5(2) does not apply to make the supply of them ineligible. The margin scheme can also apply to the supply of Lots 4 to 6 as the entire interest in each of those lots was not acquired through a supply that was ineligible for the margin scheme. They are therefore not excluded by subsection 75-5(2).

155. If the margin scheme is applied to supplies of Lots 4 to 6, there are increasing adjustments under subsection 75-22(1). The increasing adjustment for each supply is a proportionate amount of the previously attributed input tax credit amount for the acquisition of the land. You may use any fair and reasonable basis of apportionment to work out the increasing adjustment.

Stratum unit

156. 'Stratum unit' is defined in section 195-1 as having 'the meaning given by subsection 124-190(3) of the *Income Tax Assessment Act 1997*. Subsection 124-190(3) defines a stratum unit as 'a lot or unit (however described in an Australian law or a foreign law relating to strata title or similar title) and any accompanying common property.' The Commissioner considers that the reference to 'similar title' in the definition of stratum unit includes other arrangements such as group title arrangements.

157. The definition of stratum unit in section 195-1 encompasses a legal arrangement where real property is divided into units or allotments and common property. The common property is usually held by a body corporate as agent for the land owners as tenants in common.

158. For the purpose of the discussion below, the term 'strata title' refers to a strata plan where the boundaries of unit are defined by reference to the structures (for example, walls floors and ceilings). For example, a single building divided into units.

159. In the discussion below the term 'group title' refers to arrangements where the real property is divided into allotments of land and common property. The boundaries are defined by reference to land rather than by reference to building structure.

Strata title

160. If you acquire adjoining properties, one of which was acquired through a supply that is ineligible for the margin scheme, and you then construct stratum units on the properties, then ordinarily some part of the common property will be constructed on land that was acquired through a supply that:

- is eligible for the margin scheme; and
- is ineligible for the margin scheme.

161. In these circumstances, all of the stratum units have been partly derived from land that was acquired through a supply that was ineligible for the margin scheme. The supply of these units can be made under the margin scheme as subsection 75-5(2) does not apply. However, because the units were partly acquired through land that was ineligible for the margin scheme you have an increasing adjustment under subsection 75-22(1). The increasing adjustment is the proportionate amount of the input tax credits for the acquisition of the land referable to the supply of each stratum unit.

GSTR 2006/8

Example 16: stratum units

162.



- 10 stratum units are then built on the land.

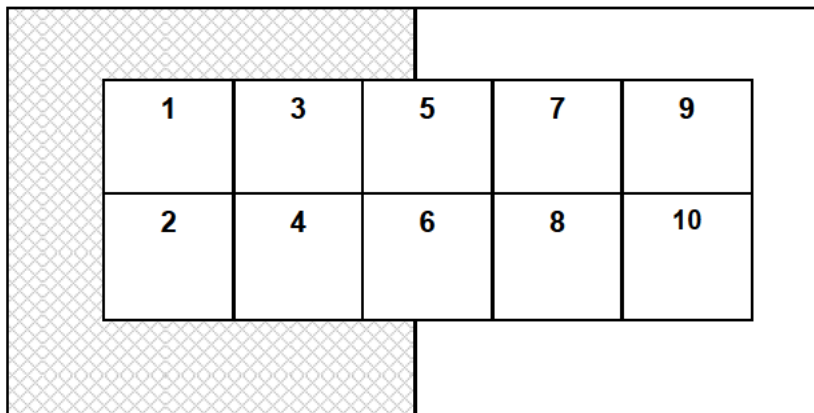

163. In the context of the diagram, the real property that was acquired through a supply that would have been ineligible for the margin scheme is shaded.

164. The common property in this example is made up of property that was acquired through a supply that was ineligible for the margin scheme as well as property that was eligible for the margin scheme.

165. Therefore, the margin scheme can apply to the supply of all the stratum units as the entire interest in each of the stratum units, including the common property, was not acquired through a supply that was ineligible for the margin scheme. They are therefore not excluded from the margin scheme by subsection 75-5(2).

166. If the margin scheme is applied to the supply of any of the stratum units, there is an increasing adjustment under subsection 75-22(1). The increasing adjustment is equal to the proportion of the input tax credit for the acquisition of the land that relates to the stratum unit supplied. To ascertain the extent of the increasing adjustment, you may use any reasonable basis of apportionment.

Group title

167. The margin scheme can be used in group title arrangements where:

- the allotment and the common property have been entirely derived from land that was acquired through a supply that was eligible for the margin scheme;
- the allotment was derived entirely from land that the margin scheme can apply to but some or all of the common property was derived from land that was acquired through a supply that was ineligible for the margin scheme. In these circumstances, you have an increasing adjustment to the extent of the input tax credit entitlement in respect of the acquisition of the allotment;
- both the allotment and the common property were partly derived from land that was acquired through a supply that was ineligible for the margin scheme. However, in these circumstances, you have an increasing adjustment to the extent of the input tax credit entitlement in respect of the acquisition of the allotment.

Subsection 75-22(2)

168. Subsection 75-22(2) is effective from 17 March 2005. Under subsection 75-22(2), you may use the margin scheme if you inherit real property and the deceased acquired part of that property through a supply that was ineligible for the margin scheme. An example of this is where:

- you inherit real property from the deceased;
- the deceased acquired two adjoining properties and one of the properties acquired was ineligible for the margin scheme and the margin scheme could be applied to the other property; and
- the deceased subdivided the properties, or constructed stratum units on them.

169. If you apply the margin scheme in these circumstances you have an increasing adjustment to the extent of any input tax credits for the acquisition of the land.

170. The increasing adjustment is worked out in the same manner as indicated in paragraphs 155 and 161.

Supplies made on or after 17 March 2005 where the full consideration for the acquisition has not been paid

171. If an entity makes supplies of real property but does not pay the full contract price for the acquisition of that property, section 75-12 applies. It provides that the margin for the supply is worked out as the amount by which the consideration for the supply exceeds the consideration paid for the acquisition (which may not be the consideration for the acquisition reflected in the contract). Section 75-12 is effective from 17 March 2005.

Example 17: full consideration not paid for supply

172. *Terry supplies real property to Adam. The consideration for the supply is \$770,000. However, Adam only pays Terry \$700,000. Adam then sells the property to Wendy for \$1,100,000 and uses the margin scheme to calculate the GST payable on the supply. When Adam calculates the margin for the supply, the consideration for the acquisition is the amount he paid Terry (\$700,000).*

173. *The margin for the supply is \$400,000 (\$1,100,000 - \$700,000).*

Decreasing adjustment for later payment of consideration

174. If section 75-12 applies, and you later make a further payment of the acquisition consideration, you have a decreasing adjustment under section 75-27. Subsection 75-27(2), which is effective from 17 March 2005, provides that the amount of the decreasing adjustment is equal to 1/11th of the further amount of consideration paid.

Example 18: decreasing adjustment where consideration for a supply paid later

175. *Using the facts in the example shown above, if Adam subsequently pays Terry the remaining \$70,000, he has a decreasing adjustment of \$6,364 ($1/11 \times \$70,000$).*

Entitlement to input tax credits

176. If the GST payable on a supply of real property has been worked out under the margin scheme, the acquisition of the property by the recipient of the supply is not a creditable acquisition. This means that the recipient is not entitled to an input tax credit for the acquisition of the real property.³⁶

³⁶ Section 75-20.

Tax invoices

177. A supplier is not required to issue a tax invoice for a taxable supply that is solely a supply of real property under the margin scheme.³⁷

Record keeping requirements

178. Section 382-5 of Schedule 1 to the TAA requires you to keep records that record and explain all transactions and other acts that you engage in that are relevant to the supply. You must retain these records for at least 5 years after the completion of the transactions or acts to which they relate.

179. As well as retaining accounting records documenting the transaction, you must also retain records showing how you have applied the margin scheme. Examples of these records include:

- (a) contracts of sale and purchase together with settlement statements;
- (b) details of how you worked out the margin for any supply of real property under the margin scheme; and
- (c) documents describing the real property at the date it was acquired.

180. For supplies made on or after 17 March 2005, the following records must also be retained:

- (a) if applicable, the approved valuation or GST inclusive market value you obtained;
- (b) any written request for a further period to obtain an approved valuation and the Tax Office response; and
- (c) if an approved valuation is required, documents describing the real property at the valuation date.

181. For supplies made on or after 29 June 2005³⁸ to which subsection 75-5(1A) applies, the following records must also be retained:

- (a) the agreement in writing to use the margin scheme; and
- (b) the request for a further period in which to agree to use the margin scheme and the Tax Office response.

³⁷ Section 75-30.

³⁸ The date of Royal Assent of the 2005 Amendment Act.

Detailed contents list

182. Below is a detailed contents list for this Goods and Services Tax Ruling:

	Paragraph
What this Ruling is about	1
Date of effect	6
Margin scheme rulings	11
Background	12
Ruling with Explanation	15
When can you apply the margin scheme?	15
<i>Amended subsection 75-5(1) and subsection 75-5(1A)</i>	18
<i>Subsection 75-5(1) prior to its amendment</i>	20
<i>Conditional application of the margin scheme</i>	27
Supplies made before 17 March 2005 to which the margin cannot be applied	29
<i>Example 1: former subsection 75-5(2)</i>	30
Supplies made on or after 17 March 2005 that are ineligible for the margin scheme	32
<i>Example 2: GST groups</i>	33
When do you supply or acquire real property?	36
Can you use the margin scheme when you supply a tenancy in common interest in real property?	40
How is the margin for the supply calculated under subsection 75-10(2)?	45
Consideration for the supply and settlement adjustments	47
Consideration for the acquisition	48
Alternative view	50
The effect of section 75-14 on supplies made on or after 17 March 2005	54
<i>Example 3: section 75-14</i>	56
Apportionment methods	58
<i>Example 4: area basis</i>	62
<i>Example 5: lots area</i>	64
<i>Example 6: anticipated sales price</i>	65
<i>Example 7: multi-staged developments</i>	68
The effect of section 75-11 on supplies made on or after 17 March 2005	69

Supply of real property made on or after 17 March 2005 if the acquisition is from a fellow member of a GST group	72
<i>Subsection 75-11(1)</i>	72
<i>Paragraph 75-11(1)(c)</i>	74
<i>Example 8: GST groups where earlier supply made on or after 1 July 2000</i>	76
<i>Paragraph 75-11(1)(d)</i>	79
<i>Example 9: GST groups and associates where earlier supply made on or after 1 July 2000</i>	81
<i>Subsection 75-11(2)</i>	84
<i>Example 10: GST group where earlier supply made before 1 July 2000</i>	86
Supply of real property made on or after 17 March 2005 where the real property was acquired from a joint venture operator	88
<i>Subsection 75-11(2A)</i>	89
<i>Subsection 75-11(2B)</i>	92
Supply of real property made on or after 17 March 2005 where the acquisition was from a deceased estate	94
<i>Paragraph 75-11(3)(d)</i>	99
<i>Paragraph 75-11(3)(e)</i>	101
<i>Subsection 75-11(4)</i>	102
Supply of real property made on or after 17 March 2005 where the real property was acquired from an associate	106
<i>Example 11: real property acquired from an associate</i>	108
<i>Subsection 75-11(8)</i>	110
Supply of real property to an associate where the supply is made on or after 17 March 2005	112
<i>Example 12: supplies to associates</i>	113
Approved valuations	115
Valuation dates	120
Time to make valuations	121
What is the real property that you value?	126
<i>Example 13: valuing real property that is subdivided after the valuation date</i>	129
Professional valuers	130
Documentation that a professional valuer is required to provide	132

Can you apply the margin scheme when you make a supply of real property that has separately identifiable taxable and non-taxable (that is, GST-free or input taxed) parts?	133
Approved valuation	137
GST-inclusive market value	139
How do you calculate the GST inclusive sale price and the margin?	144
<i>Example 14: where only the GST inclusive price is known</i>	145
Increasing adjustments for supplies made on or after 17 March 2005, where part of the acquisition was ineligible for the margin scheme	147
<i>Subsection 75-22(1)</i>	147
Subdivision of broadacres	150
<i>Example 15: subdivision of broadacres</i>	152
Stratum unit	156
Strata title	160
<i>Example 16: stratum units</i>	162
Group title	167
<i>Subsection 75-22(2)</i>	168
Supplies made on or after 17 March 2005 where the full consideration for the acquisition has not been paid	171
<i>Example 17: full consideration not paid for supply</i>	172
Decreasing adjustment for later payment of consideration	174
<i>Example 18: decreasing adjustment where consideration for a supply paid later</i>	175
Entitlement to input tax credits	176
Tax invoices	177
Record keeping requirements	178
Detailed contents list	182

Commissioner of Taxation

26 April 2006

Previous draft:
GSTR 2005/D4

Related Rulings/Determinations:

GSTD 2004/2; GSTD 2006/3;
GSTR 1999/1; GSTR 2000/21;
GSTR 2004/2; GSTR 2006/6;
GSTR 2006/7

Subject References:

- freehold interest
- long-term lease
- margin
- margin scheme
- real property
- stratum unit
- taxable supply
- valuation

Legislative References:

- ANTS(ABN)A 1999 41
- ANTS(GST)A 1999 9-70
- ANTS(GST)A 1999 9-75
- ANTS(GST)A 1999 19-75
- ANTS(GST)A 1999 Subdiv 38-N
- ANTS(GST)A 1999 38-445(1A)
- ANTS(GST)A 1999 38-450
- ANTS(GST)A 1999 48-40(2)
- ANTS(GST)A 1999 51-5
- ANTS(GST)A 1999 51-30(2)
- ANTS(GST)A 1999 51-70(1)(a)
- ANTS(GST)A 1999 Div 72
- ANTS(GST)A 1999 Subdiv 72-D
- ANTS(GST)A 1999 72-95
- ANTS(GST)A 1999 72-100
- ANTS(GST)A 1999 Div 75
- ANTS(GST)A 1999 75-5
- ANTS(GST)A 1999 75-5(1)
- ANTS(GST)A 1999 75-5(1)(a)
- ANTS(GST)A 1999 75-5(1)(c)
- ANTS(GST)A 1999 75-5(1A)
- ANTS(GST)A 1999 75-5(1A)(a)
- ANTS(GST)A 1999 75-5(1A)(b)
- ANTS(GST)A 1999 75-5(2)
- ANTS(GST)A 1999 75-5(3)
- ANTS(GST)A 1999 75-5(3)(c)
- ANTS(GST)A 1999 75-10(2)
- ANTS(GST)A 1999 75-10(3)
- ANTS(GST)A 1999 75-10(3)(b)
- ANTS(GST)A 1999 75-10(3A)
- ANTS(GST)A 1999 75-11
- ANTS(GST)A 1999 75-11(1)
- ANTS(GST)A 1999 75-11(1)(c)
- ANTS(GST)A 1999 75-11(1)(d)
- ANTS(GST)A 1999 75-11(2)
- ANTS(GST)A 1999 75-11(2A)
- ANTS(GST)A 1999 75-11(2A)(d)
- ANTS(GST)A 1999 75-11(2A)(e)
- ANTS(GST)A 1999 75-11(2B)
- ANTS(GST)A 1999 75-11(3)
- ANTS(GST)A 1999 75-11(3)(ca)
- ANTS(GST)A 1999 75-11(3)(d)
- ANTS(GST)A 1999 75-11(3)(e)
- ANTS(GST)A 1999 75-11(4)

- ANTS(GST)A 1999 75-11(4)(d)
- ANTS(GST)A 1999 75-11(4)(e)
- ANTS(GST)A 1999 75-11(7)
- ANTS(GST)A 1999 75-11(7)(c)
- ANTS(GST)A 1999 75-11(7)(d)
- ANTS(GST)A 1999 75-11(8)
- ANTS(GST)A 1999 75-12
- ANTS(GST)A 1999 75-13
- ANTS(GST)A 1999 75-14
- ANTS(GST)A 1999 75-15
- ANTS(GST)A 1999 75-20
- ANTS(GST)A 1999 75-20(1)
- ANTS(GST)A 1999 75-22(1)
- ANTS(GST)A 1999 75-22(2)
- ANTS(GST)A 1999 75-25(1)(a)
- ANTS(GST)A 1999 75-27
- ANTS(GST)A 1999 75-27(2)
- ANTS(GST)A 1999 75-30
- ANTS(GST)A 1999 75-30(1)
- ANTS(GST)A 1999 75-35
- ANTS(GST)A 1999 75-35(2)
- ANTS(GST)A 1999 195-1
- ITAA 1936 318
- ITAA 1997 124-190(3)
- TAA 1953 105-60
- TAA 1953 110-50(2)
- TAA 1953 382-5
- PSA 1999
- Tax Laws Amendment (2005 Measures No. 2) Act 2005
- Tax Laws Amendment (2005 Measures No. 2) Act 2005 Sch 6
- Tax Laws Amendment (2008 Measures No. 5) Act 2008

Case References:

- Nullagine Investments Pty Ltd v. Western Australian Club Inc (1993) 177 CLR 635
- Sterling Guardian Pty Limited v. Commissioner of Taxation [2006] FCAFC 12

Other References:

- A New Tax System (Goods and Services Tax) Margin Scheme Valuation Requirements Determination (No. 1) 2000
- A New Tax System (Goods and Services Tax) Margin Scheme Valuation Requirements Determination (No. 2) 2000
- A New Tax System (Goods and Services Tax) Margin Scheme Valuation Requirements Determination MSV 2005/1

GSTR 2006/8

- A New Tax System (Goods and Services Tax) Margin Scheme Valuation Requirements Determination MSV 2005/2
 - A New Tax System (Goods and Services Tax) Margin Scheme Valuation Requirements Determination MSV 2005/3
 - A New Tax System (Goods and Services Tax) Margin Scheme Valuation Requirements Determination MSV 2009/1
 - Australian Legal Dictionary, 1997, Butterworths
 - Law Administration Practice Statement PS LA 2005/15
 - Law Administration Practice Statement PS LA 2005/16
 - Law Administration Practice Statement PS LA 2005/2 (GA)
 - Revised Explanatory Memorandum to the Tax Laws Amendment (2005 Measures No. 2) Bill 2005
-

ATO references

NO: 2005/9926

ISSN: 1443-5160

ATOlaw topic: Goods and Services Tax ~~ Property and construction ~~ margin scheme
Goods and Services Tax ~~ Miscellaneous rules ~~ deceased estates